

# Terminal Blocks

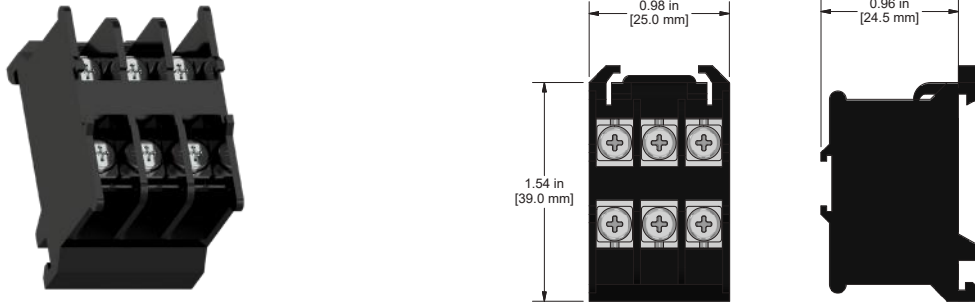

## JB934-1A

Terminal Block, Black, One Piece, Three Position, Din Rail Mountable



## JB934-2A

Terminal Block, White, One Piece, Four Position, Din Rail Mountable

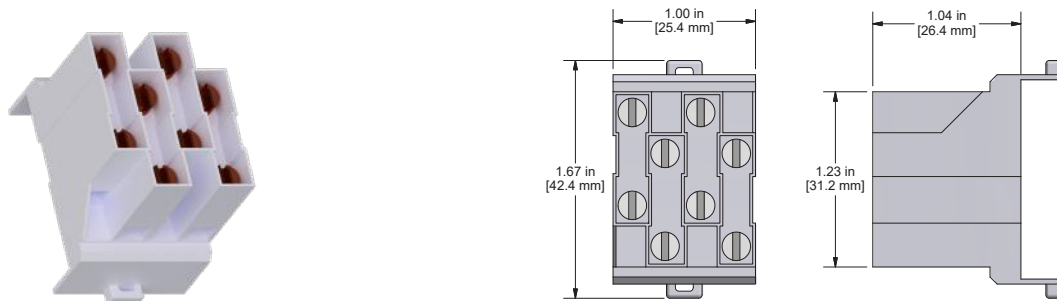

## JB939-1A

3 Position Terminal Block aligned in one row

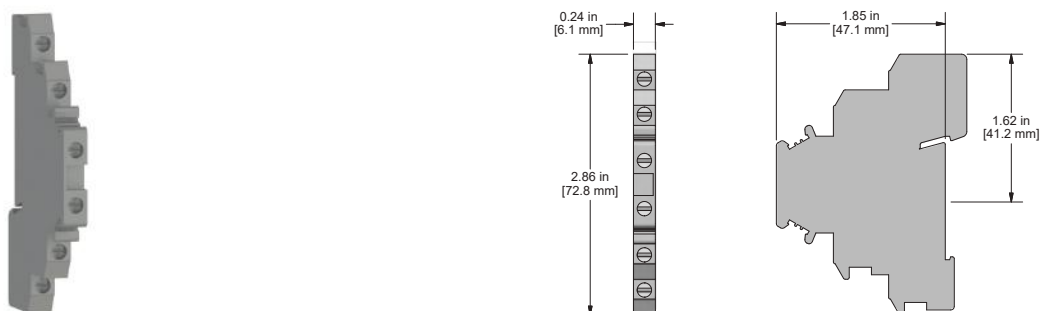

# JB932

5 Position Plugs for CTC Enclosures



## JB932-1A

5 Position Plug, Spring Cage, for use with Triaxial Compatible Junction Boxes

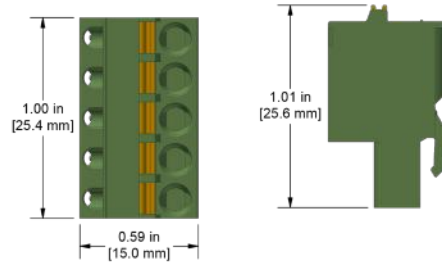

## JB932-2A

5 Position Plug, Screw Terminal, for use with Triaxial Compatible Junction Boxes

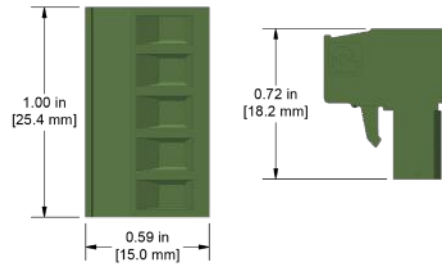

## JB933-1A

5 Position "T" Plug, Screw Terminal, for Continuous Output Pass Through in Triaxial Compatible Junction Boxes

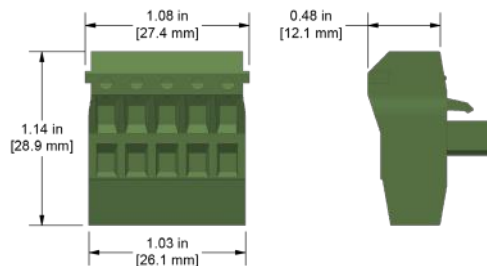

Backed by our Unconditional Lifetime Warranty

[www.ctconline.com](http://www.ctconline.com) | [sales@ctconline.com](mailto:sales@ctconline.com) | 585-924-5900

# JB930

4 Position Plugs for CTC Enclosures



## JB930-1A

4 Position Plug, Spring Cage, for use in Dual Output Compatible Junction Boxes

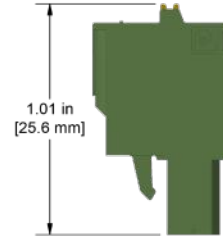
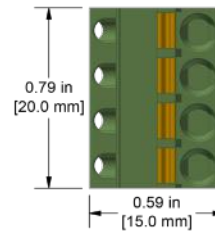

## JB931-1A

4 Position Plug, Screw Terminal, for use in Dual Output Compatible Junction Boxes

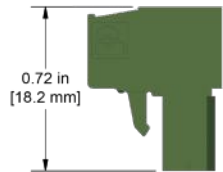
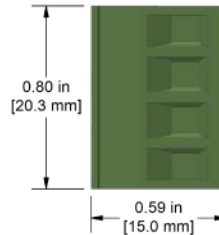
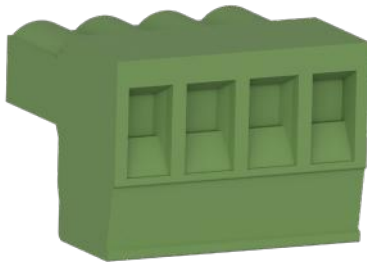

## JB931-3A

4 Position "T" Plug, Screw Terminal, for Continuous Output Pass Through in Dual Output Compatible Junction Boxes

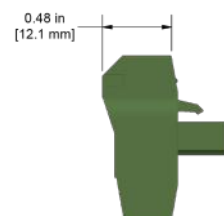
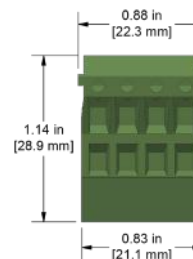

Backed by our Unconditional Lifetime Warranty

[www.ctconline.com](http://www.ctconline.com) | [sales@ctconline.com](mailto:sales@ctconline.com) | 585-924-5900

# JB907

3 Position Plugs for CTC Enclosures



## JB907-1A

3 Position Plug, Spring Cage, for use in Single Axis Compatible Junction Boxes

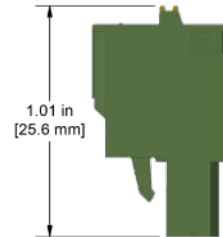
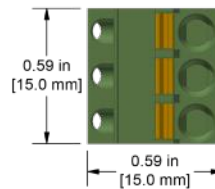
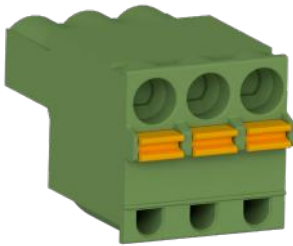

## JB907-2A

3 Position Plug, Screw Terminal, for use in Single Axis Compatible Junction Boxes

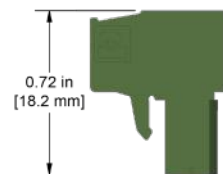
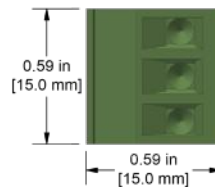

## JB907-3A

3 Position "T" Plug, Screw Terminal, for Continuous Output Pass Through in Single Axis Compatible Junction Boxes

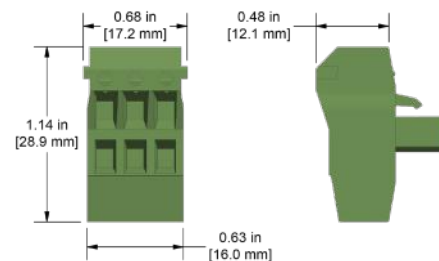

Backed by our Unconditional Lifetime Warranty

[www.ctconline.com](http://www.ctconline.com) | [sales@ctconline.com](mailto:sales@ctconline.com) | 585-924-5900

# Junction Box Terminals

Multi Position Plugs for CTC Enclosures



## JB905-1A

12 Position Plug, Spring Cage, for connection to online system interface jacks on CTC SB Series Switch Boxes\*

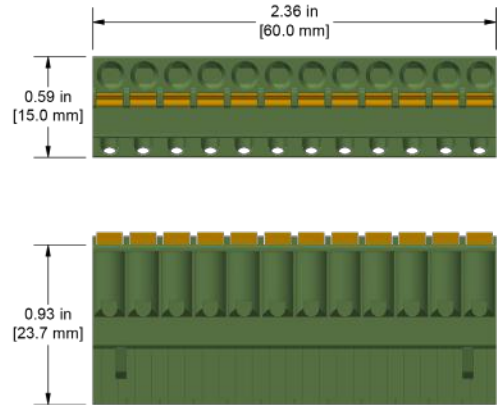
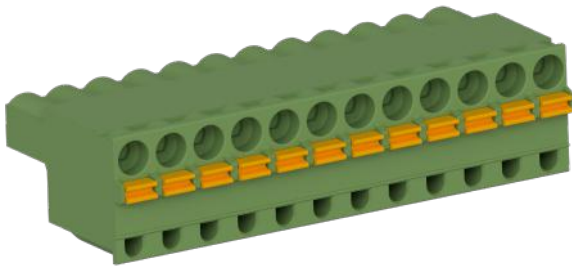

## JB905-2A

12 Position Plug, Screw Terminal, for connection to online system interface jacks on CTC SB Series Switch Boxes\*

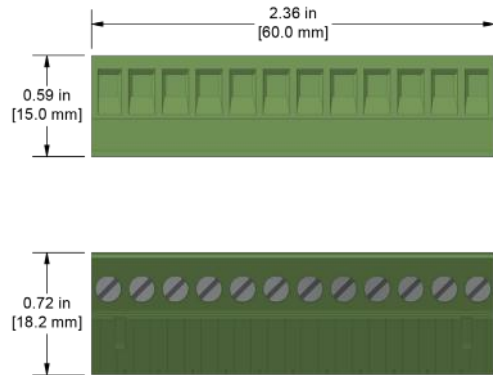
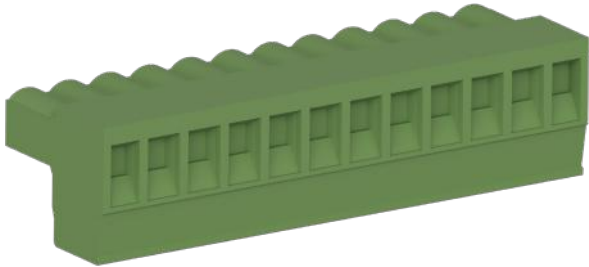

## JB907-4A

9 Position "T" Plug, Screw Terminal, for Continuous Output Pass Through in MMX-MOD3 Modules†

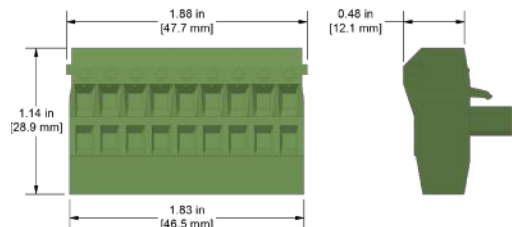

\*One block will accommodate 6 channels

†One block will accommodate each module

Backed by our Unconditional Lifetime Warranty

[www.ctconline.com](http://www.ctconline.com) | [sales@ctconline.com](mailto:sales@ctconline.com) | 585-924-5900